

## Constable Selection System

---

# Orientation and Pre-Test Guide



# Ontario's Constable Selection System - Overview

---

So you want to be a police officer...

As a first step, read all you can about the job and then answer the questions in this booklet to help you figure out if this is really the right job for you. If you're sure, register to take the first set of tests in the Constable Selection System.

## Stage 1: Pre-interview assessments

These are the first set of tests you'll have to take:

- A two-part written test
- A fitness test specially designed for police officers
- A test that uses a video simulation of crime investigations
- A vision test and a hearing test

Pass these tests and you can apply to the police service where you'd like to work.

## Stage 2: Interviews

If the police service you've applied to is interested in you, you'll need to:

- Answer a questionnaire about your background
- Have an interview that assesses your skills plus your ability to learn new skills
- There may be a second interview to assess how you'd fit in with any particular needs the police service might have

## Stage 3: Post-Interview Assessments (if successful in the interview)

- The police service to which you've applied will conduct a background and a reference check
- You'll have a psychological assessment
- If the police service to which you've applied wants to hire you, you'll have one more test -- a medical check-up

At this point, the police service may hire you for a probationary period. If you succeed during this probation, you'll be well on your way to becoming a police officer.

---

# Table of Contents

---

INTRODUCTION .....	4
THE ASSESSMENT PROCESS .....	5
Stage 1: Pre-Interview Assessments.....	6
Police Analytical Thinking Inventory (PATI).....	6
Written Communication Test (WCT).....	8
Physical Readiness Evaluation for Police (PREP).....	9
Behavioural Personnel Assessment Device (BPAD).....	12
Technician-administered vision and hearing assessments.....	13
Stage 2: Interviews.....	15
Essential Competencies Interview (ECI).....	15
Pre-Background Questionnaire (PBQ).....	16
Stage 3: Post-Interview Assessments.....	17
TESTING TIPS AND PRACTICE EXERCISES.....	18
Testing Tips.....	18
Practice Exercises.....	19

# Introduction

---

This guide is written to provide you with information and guidance as you navigate your way through the Ontario Association of Chiefs of Police Constable Selection System.

The information in this booklet is organized under two headings:

- The Assessment Process
- Testing Tips and Practice Exercises

This document complements other information about the Constable Selection System, including:

- Policing in Ontario: Applicant Information
- Self Assess! Medical Requirements for Candidates
- Fit to Serve: Preparing for the Physical Readiness Evaluation for Police (PREP)

You can find these and other helpful publications at the following websites:

<http://www.mcscs.jus.gov.on.ca>, <http://www.oacp.on.ca>, <http://www.opp.ca>, and <http://www.applicanttesting.com>. Please note that hardcopy booklets are no longer available.

# The Assessment Process

---

The Constable Selection System consists of three stages of assessment: Pre-Interview, Interview and Post-Interview. You must pass each stage in order to be eligible for final consideration.

## Stage 1

### Part 1

- Police Analytical Thinking Inventory (PATI) – written
- Written Communication Test (WCT) – written
- Physical Readiness Evaluation for Police (PREP) – physical

### Part 2

- Behavioural Personnel Assessment Device (B-PAD) – simulations/video
- Vision test and Hearing Assessment

**Note:** You can only proceed to the B-PAD and Vision and Hearing Assessments once you have successfully completed Part 1.

## Stage 2

- Essential Competency Interview (ECI)
- Pre-Background Questionnaire (PBQ)

## Stage 3

- Post Interview Assessments

Once you have successfully completed Stage 1, you are provided with a Certificate of Results (COR) and can proceed to apply to individual police services, after which point you may be invited by a service to proceed to Stage 2, and if successful, Stage 3, the conditional job offer and post interview assessments.

# The Assessment Process

---

## Stage 1 - Pre-Interview Assessments

The first stage is conducted by Applicant Testing Services, and consists of two parts. Part 1 consists of Police Analytical Thinking Inventory (PATI) and Written Communication Test (WCT). Part 2 consists of the Physical Readiness Evaluation for Police, Behavioural Personnel Assessment Device (B-PAD), Vision and Hearing Assessments.

Stage 1 consists of the following four tests:

### PART 1

#### Police Analytical Thinking Inventory (PATI)

##### Description:

This test is called the Police Analytical Thinking Inventory (PATI). The PATI tests three key types of reasoning police constables require when performing their jobs. These are:

- **Deductive Reasoning:** The ability to draw appropriate conclusions from information provided. Police are often required to make sense of evidence by drawing conclusions about its relevance and meaning. This is tested through the Syllogism and Travel Time tasks.
- **Inductive Reasoning:** The ability to identify trends or common characteristics in a series of objects or information presented. Police officers often need to sift through seemingly disconnected facts and make judgments about how they fit together. This is tested through the Classification and Series Completion tasks.
- **Quantitative Reasoning:** The ability to apply basic arithmetic operations like addition, subtraction, multiplication and division to solve problems. Police are required to apply arithmetic processes to determine rates of speed, stopping distance, etc. and this ability is tested with Word Problems and Arithmetic tasks.

##### Test Administration:

- The PATI is a timed, multiple choice paper-and-pencil test. The test takes one hour and 45 minutes (consisting of 15 minutes for administration and 1.5 hours for the test itself.)
- A French version of the PATI is available for those applicants wishing to write the PATI in French. Applicants are asked to indicate this when registering for testing.
- Please note that all the other testing components will be available in English only.

# The Assessment Process

---

## **Police Analytical Thinking Inventory (PATI) (cont'd)**

### **Validity Period:**

A successful PATI test is valid for three years.

### **Re-Test:**

If you are unsuccessful at your first attempt at the PATI, you must wait a minimum of three months before you try again. If you are unsuccessful on subsequent attempts, you must wait at least six months before taking the test again.

When a successful PATI test is due to expire, you may rewrite the test two months prior to the expiry date, or anytime afterwards.

# The Assessment Process

---

## Written Communication Skills (WCT)

### Description:

This test is called the Written Communication Skills (WCT) and evaluates your ability to comprehensively record, interpret, organize and express information in a technically correct and legible manner.

In this test, you are presented with a scenario in which facts are jumbled or represented in a non-chronological manner.

### Test Administration:

The written communication skills test is a timed paper-and-pencil English test. The test takes approximately one hour and 15 minutes: 15 minutes for administration and one hour for the test itself.

### Validity Period:

A successful written communications test is valid for three years.

### Re-test:

If you are unsuccessful at your first attempt at the written communications test, you must wait a minimum of three months before you try again. If you are unsuccessful on subsequent attempts, you must wait at least six months before taking the test again.

When a successful written communications test is due to expire, you may rewrite two months prior to the expiry date, or anytime afterwards.



---

# The Assessment Process

---

## Physical Readiness Evaluation for Police (PREP)

This test is called the Physical Readiness Evaluation for Police (PREP). It consists of a number of procedures. Detailed information on the assessment for physical skills and abilities is outlined in Fit to Serve: PREP - Preparing for the Physical Readiness Evaluation for Police, accessible at the following websites: <http://www.mcscs.jus.gov.on.ca>, <http://www.oacp.on.ca>, <http://www.opp.ca>, and <http://www.applicanttesting.com>. Please note that hardcopy booklets are no longer available.

### Description:

- **Physical Fitness:** Pass all components of the PREP test, which includes:
- **Pursuit/Restraint Circuit:** The Pursuit/Restraint Circuit is made up of four 25 meter rotations. In the pursuit phase of the test, you will run four laps around a 25 metre (82 ft) circuit as quickly as possible for a total distance of 100 metres (328 ft). During the first and third rotations you will pull yourself up to look over a 1.9 metre (6.5 ft) fence with a toe hold, climb up and down a set of stairs, drop to the floor and crawl under a barrier of 61 cm (24 in). During the second and fourth rotations of the circuit; you will scale a 1.2 metre (4 ft) fence with no toe-holds), climb up and down a set of stairs and then drop to the floor and crawl under a barrier of 61 cm (24 in). During the second and fourth rotations of the circuit; you will scale a 1.2 metre (4 ft) fence, climb up and down a set of stairs and then drop to the floor and crawl under a barrier of 61 cm (24 in), then go first to the Body Control Simulator and then to the Arm Restraint Simulator. The participant then drags a 170 lb. rescue victim a distance of 50 feet. Six of those feet are over a resistance mat. The standard for successful completion of the Pursuit/Restraint Circuit is 157 seconds or less.

# The Assessment Process

---

## Physical Readiness Evaluation for Police (PREP) (cont'd)

- **Aerobic Shuttle Run:** The time permitted to cover the 20 metres of the aerobic shuttle run at the beginning of the test requires a slow jog. Thereafter, for each 20 metres, the time between audio signals lessens, requiring that you pick up your running pace. The audio signal informs you of the “stage” you are at as the test progresses. In each leg of the Shuttle Run, warning lines, placed 2 metres (7ft) before each of the 20 metre end lines, must be reached before the permitted time elapses and the audio signal sounds. You will be cautioned by an examiner if you fail to cross a warning line in time and you must still reach the end line before returning. The test ends when you miss two consecutive warning lines. To successfully complete the minimum requirement of the aerobic fitness test you must achieve Stage 7.0 in the 20 metre Shuttle Run.

### Test Administration:

This assessment procedure takes about 20 minutes to complete. Before taking part in the PREP test, you will be required to complete the Physical Activity Readiness Questionnaire, PAR-Q+ (and if required, the ePARmed-X+ at [www.eparmedx.com](http://www.eparmedx.com)). Always use the most recent PAR-Q+ documents available, which can be found at [www.eparmedx.com](http://www.eparmedx.com). A printed copy of the most recent PAR-Q+ is available from Applicant Testing Services. This health inventory identifies acute or chronic conditions that could pose a risk during exercise and which need to be cleared by a qualified exercise professional with advanced specialized university training and/or a physician. If additional clearance is required, have a physician or a qualified exercise professional with advanced university specialized training, sign the appropriate PREP Physical Activity Readiness Conveyance/Referral Form.

If you are 45 years of age or less, and have answered “NO” to all 7 PAR-Q+ questions on pages 1, 2 and 3, and have a blood pressure less than 160/90 mmHg, you can participate in the PREP. Otherwise, you must complete the online ePARmed-X+ at [www.eparmedx.com](http://www.eparmedx.com) for further screening. Upon completion of the online ePARmed-X+ you will be issued a directive which will specify what intensity of physical activity you are cleared for.

## The Assessment Process

---

### **Physical Readiness Evaluation for Police (PREP) (cont'd)**

If you are over 45 years of age and unaccustomed to regular vigorous to maximal effort exercise consult a qualified exercise professional with advanced specialized university training prior to engaging in the PREP.

Regardless of your PAR-Q+ responses, it is suggested that you have a physical examination by a physician before participating in the PREP.

In addition, prior to participation, you must sign an Informed Consent Form which contains information about each component of the PREP test and identifies any risks associated with participation.

Forms are available from Applicant Testing Services.

- You will be required to complete and sign a PREP informed Consent Form.
- Your blood pressure will be measured prior to testing.
- Wear running shoes and exercise clothing while performing the PREP test.

### **Validity Period:**

A successful PREP test is valid for six months.

### **Re-test:**

If you are unsuccessful at your first attempt at the PREP test, you may register immediately to retake the test. If you are unsuccessful on subsequent attempts, you must wait at least two months before taking the test again. When a successful PREP test is due to expire, you may retake the test two months prior to the expiry date, or anytime afterwards.

# The Assessment Process

---

## **PART 2**

You will only take this test, and the vision and hearing assessments, if you have successfully completed the first three tests in Part 1.

### **Behavioural Personnel Assessment Device (B-PAD)**

#### **Description:**

In this test, you will watch different scenarios on television that represent what police constables might experience on the job. You must then respond as if you are speaking to the people in the television scene. Knowledge of police procedures is not required.

#### **Test Administration:**

This video simulation takes approximately 40 minutes to complete, 20 minutes for administration and 20 minutes of activity.

#### **Validity Period:**

A successful video simulation test is valid for three years.

#### **Re-test:**

If you are unsuccessful at your first attempt at the video simulation test, you must wait a minimum of three months before you try again. If you are unsuccessful on subsequent attempts, you must wait at least six months before taking the test again.

When a successful video simulation test is due to expire, you may retake the test two months prior to the expiry date, or anytime afterwards.

# The Assessment Process

---

## Technician-administered Vision and Hearing assessments

### Description:

Technician-administered vision and hearing assessments may be scheduled with the PREP test or the B-PAD video simulation testing exercise.

The following standards apply:

### Vision:

Visual Acuity for candidates who DO NOT need eyeglasses or contact lenses should be:

- At least 20/20 (6/6) with both eyes open.

Visual Acuity for candidates that DO need eyeglasses or contact lenses should be:

- At least 20/40 (6/12) with both eyes open WITHOUT the corrective lenses AND
- At least 20/20 (6/6) with both eyes open WITH the corrective lenses

There are additional minimum requirements regarding farsightedness (hyperopia), colour vision, depth perception, peripheral vision, refractive surgeries, ocular diseases and other vision-related conditions.

### Hearing:

Hearing is acceptable if these audiometrically-based hearing thresholds are met:

- Pure-tone thresholds measured under headphones not exceeding 25 dB HL in each ear at 500, 1000, 2000, 3000 and 4000 Hz

Otherwise, you will be required to undergo the headphone version of the Hearing-in-Noise-Test (HINT), a speech recognition test conducted in quiet and in noise.

**Note:** You are advised to have no exposure to loud noise of any kind during the 12 hours preceding administration of the hearing tests.

---

# The Assessment Process

---

## **Technician-administered Vision and Hearing assessments (cont'd)**

If you fail to meet the standards of any of the technician-administered vision or hearing assessments, you will be referred for further examination by an appropriate specialist. It is recommended that you evaluate your chances of meeting the vision and hearing standards before committing to the testing fees of the pre-interview stage.

For more information, consult Self-Assess! Medical Requirements for Candidates, available on the following websites: <http://www.mcscs.jus.gov.on.ca>, <http://www.oacp.on.ca>, <http://www.opp.ca>, and <http://www.applicanttesting.com>.

---

# The Assessment Process

---

## Stage 2 - Interviews

Once you have successfully completed Stage 1 you are provided with a Certificate of Results (COR) and can proceed to apply to individual police services, after which point you may be invited by a service to proceed to Stage 2. The second stage of assessment consists of a competency interview and completion of a Pre-Background Questionnaire (PBQ).

You must pass all Stage 1 requirements to proceed to this stage. Proceeding to this stage is not, however, automatic or guaranteed, but depends on the needs and interests of police services. After successfully completing all pre-interview tests, applicants will send applications to police agencies of their choosing.

### Essential Competency Interview (ECI)

#### Description:

The competency interview is designed to explore how you react in various situations. You will be asked to describe your thoughts, feelings and actions in certain situations.

In terms of content, the interview is built around the essential competencies. Additional questions related to developmental competencies and organizational needs may also be included. Some police services may choose to administer a separate interview. While a panel interview (consisting of two interviewers) is recommended, a few police services have opted to use a single interviewer to conduct the interview. Such interviews are outside the purview of the Constable Selection System.

#### Administration:

You will be interviewed by a panel consisting of at least two people. The interview usually takes two to two-and-one half hours. A separate interview addressing developmental competencies and organizational needs may take one to two hours. Some police services may administer a combined interview consisting of these two interviews.

#### Validity Period:

Repeating the Essential Competency Interview (ECI) with an applicant who was successful with the ECI with another Service is currently at the discretion of the police service. However, the ECI must be repeated if a one-year period has elapsed.

#### Repeat Interview:

If you are unsuccessful at your first attempt at the ECI, you must wait a minimum of three months before your second interview. If you are unsuccessful on subsequent attempts, you must wait at least six months before trying again. Any police service which utilizes the ECI component of the Constable Selection System may offer the opportunity for an interview.

# The Assessment Process

---

## Stage 2 – Interviews (cont'd)

### Pre-Background Questionnaire (PBQ)

#### Description:

You will have to answer brief questions related primarily to character and habits, in such areas as work and school experiences, alcohol, drugs, criminal activity, credit record, etc.

These questions should be answered as accurately and truthfully as possible. Deliberate misinformation could lead to **disqualification** from the selection process.

#### Administration:

You may be required to complete a Pre-Background Questionnaire (PBQ) prior to (or following) the interview depending on the Police Service's protocol. The Police Service may then review with the candidate the information provided in the PBQ.

The PBQ takes 15-25 minutes to complete. The review of the information may take from five to 25 minutes, and is done at the discretion of the Police Service.

#### Validity Period and Re-test:

You may be required to complete a PBQ as often as you are called for an interview.



---

# The Assessment Process

---

## Stage 3 – Post – Interview Assessments

If successful in Stage 2 of the selection process, you may be asked to go through several post-interview procedures. These are the Background Check, Psychological Assessment and Medical Examination. You must pass the Background Check and the Psychological Assessment before being eligible for the Comprehensive Medical.

### Background Check

This is conducted by the Police Service and is a detailed examination of your past and present behaviours and various records. One part of this process is an examination of employment, character and school related history. Interviews may also be conducted with your neighbours. Another part of the background examination is a detailed check of records and documents in Ontario, Canada and, if necessary, other countries.

### Psychological Assessment

You will be required to complete a questionnaire that asks how you think, feel and act. The subject matter focuses on many personal issues. You may be asked to attend a personal interview with a psychologist.

### Final Review

The police service will then conduct an in-depth review of all information gathered. A job offer may then be made conditional upon you obtaining medical clearance.

### Medical Examination

A medical evaluation will be conducted to determine your medical suitability to perform the duties of a police constable.

The booklet, Self Assess! Medical Requirements for Candidates, details the medical assessment requirements. This booklet is available from the following websites:

[http://www.mcscs.ius.gov.on.ca/english/police\\_serv/const\\_select\\_sys/become\\_police\\_const/become\\_police\\_const.html](http://www.mcscs.ius.gov.on.ca/english/police_serv/const_select_sys/become_police_const/become_police_const.html); <http://www.applicanttesting.com> and <http://www.oacp.on.ca/programs-courses/constable-selection-system>

### Probationary Appointment

If a job offer is confirmed, you will be hired for a probationary period during which time you will receive academic training and field instruction under the supervision of the Police Service.

# Testing Tips and Practice Exercises

---

## Part 1 - Testing Tips

### Analytical Thinking Test

The police analytical thinking test, called the PATI, is a multiple-choice test with a 90-minute time limit. Try these tips when taking the test:

- Read the questions carefully, and be sure that you understand what is being asked.
- Try to answer each question on your own before looking at the answer options. This way, answers that are only partially correct won't confuse you.
- If you find a question difficult, skip it and go back to it after you have answered the easier ones. You don't need to answer every question correctly to pass. Mark an answer for every question, even if you are unsure of the answer.

### Written Communications Test

This test requires careful attention to details, good grammar and spelling and the ability to draw conclusions from facts. Make sure you understand the given scenario before attempting to give explanations. Answer options are not provided.

### Test Administration

There will be someone available to answer questions that may come up before the actual testing begins. If you don't understand the instructions or something seems unclear to you, keep asking until you understand. The testers are there to help you do your best.

You should arrive approximately 15 minutes early for the tests, rested and prepared for the testing sessions. Remember to bring photo identification with you.

# Testing Tips and Practice Exercises

## Part 2 – Practice Exercises

### Analytical Thinking Test

#### Instructions:

This practice test contains the six different types of questions you will be asked to answer on the PATI. At the beginning of each new section, you will be told how to approach each type of question.

An answer sheet is included at the end of this practice test. Tear off the answer sheet and use it to record your answers. The correct answers and a brief explanation are also included at the end of this test. Some of the test questions are easy and some are more difficult; this will be the case when you actually take the PATI. Do your best to answer the questions here.

In order to simulate the actual testing time frame, you should try to complete this practice test in 20 minutes.

### Part1 TravelTime

Below you will see a picture, an arrow indicating compass directions, and instructions on how to use the picture. Read the instructions and use this information to answer all of the Travel Time questions. Circle the letter of the correct answer. Go to the answer section at the end of the sample items to check your work.

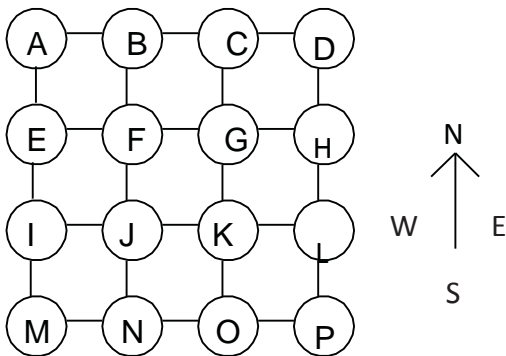

Each line represents one block of a two-lane road. You may only travel on the roads. Unless you are specifically told you must travel by a particular method, you may travel by any method or combination of methods. Unless you are specifically told otherwise, the travel times are as follows: The time required to drive one block is two minutes. Riding a bike takes three minutes per block. Pursuits on foot take five minutes per block.

# Testing Tips and Practice Exercises

## Part 2 – Practice Exercises

- 1) Using any method or combination of methods, what is the shortest amount of time it would take to get from B to C?
  - a) 2 minutes
  - b) 3 minutes
  - c) 5 minutes
  - d) 6 minutes
  
- 2) Using any method or combination of methods you choose, what is the shortest amount of time it would take to travel from C to M?
  - a) 12 minutes
  - b) 15 minutes
  - c) 10 minutes
  - d) None of the above
  
- 3) Every corner taken by car adds one minute to your drive. Using any method or combination of methods you choose, what is the shortest amount of time it would take to travel from M to G?
  - a) 8 minutes b) 9 minutes c) 11 minutes
  - d) None of the above

## Part 2 Arithmetic

- 4) Solve for m.  $3+6= m$ 
  - a) 3
  - b) 6
  - c) 9
  - d) None of the above

# Testing Tips and Practice Exercises

## Part 2 – Practice Exercises

5) Which number is largest?

a)  $\frac{18}{2}$

b)  $\frac{19}{1}$

c)  $\frac{6}{6}$

d)  $\frac{22}{23}$

6) Solve for m

$$4 - 3(m + 1) = (-38)$$

a) 13

b) -32

c) -38

d) None of the above

## Part 3 Classification

# Testing Tips and Practice Exercises

## Part 2 – Practice Exercises

7) Select the figure that does not belong.

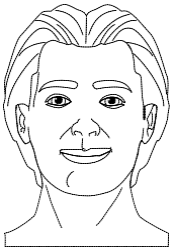

A

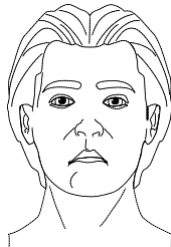

B

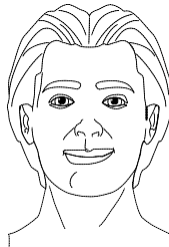

C

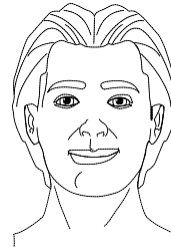

D

8) Select the figure that does not belong.

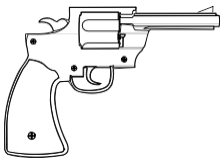

A

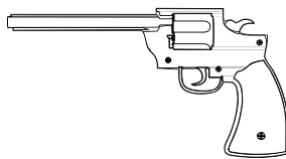

B

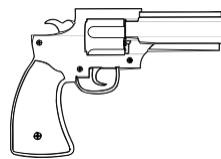

C

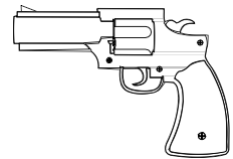

D

9) Select the figure that does not belong.

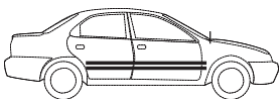

A

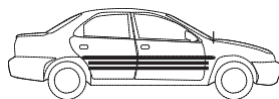

B

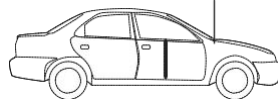

C

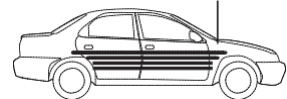

D

## Part 4 Word Problems

# Testing Tips and Practice Exercises

## Part 2 – Practice Exercises

- 10) There are two police officers and six firearms. What is the average number of firearms per officer?
- a) 2
  - b) 3
  - c) 5
  - d) 6
- 11) The month has 31 days. On even numbered days, section A of the city is patrolled. On odd numbered days, section B of the city is patrolled. How many days of the month is Section B patrolled?
- a) 14
  - b) 15
  - c) 16
  - d) None of the above
- 12) A television and a computer were stolen. Together, they were sold for \$1500. From that total, the television was sold for \$300. The computer was sold for 50% of its original worth. How much was the computer originally worth?
- a) \$ 600
  - b) \$1200
  - c) \$2400
  - d) None of the above

### Part 5 Syllogisms

--

---

# Testing Tips and Practice Exercises

---

## Part 2 – Practice Exercises

- 13) All boys are people.  
All people are alive.
- a) All boys are alive
  - b) Some boys are not alive
  - c) Some boys are not people
  - d) None of the above conclusions are valid
- 14) All prisoners are criminals.  
All thieves are prisoners.
- a) Some thieves are criminals
  - b) Some thieves are not criminals c)
  - All thieves are criminals
  - d) None of the given conclusions are valid
- 15) All Chiefs of Police are police officers.  
Some Chiefs of Police are women.
- a) Some women are police officers
  - b) Some women are not police officers c)
  - All women are police officers
  - d) None of the given conclusions are valid

### Part 6 Figure Series

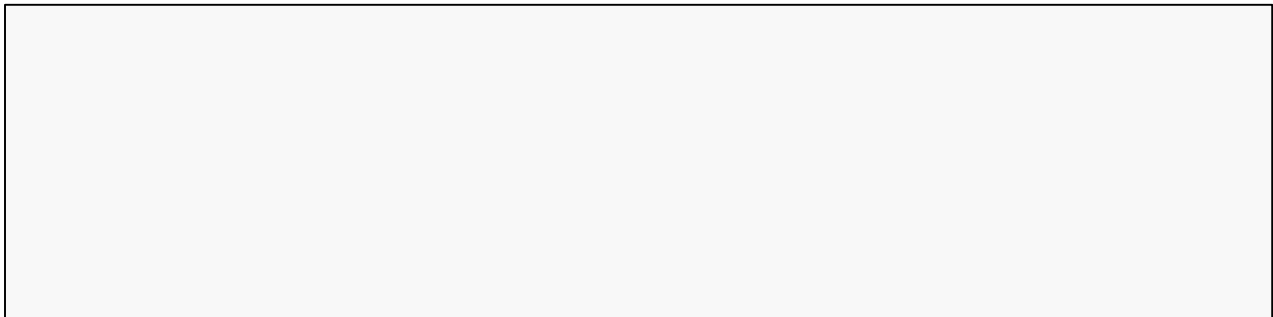



Testing Tips and Practice Exercises

Part 2 – Practice Exercises

16) Select the figure that completes the series.

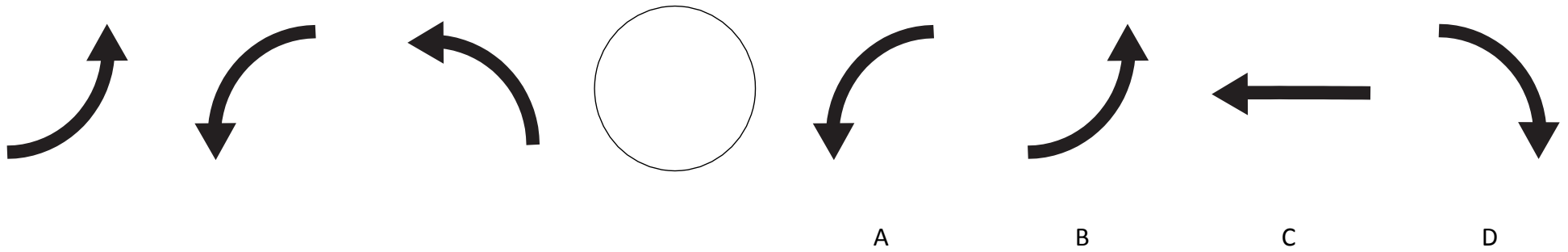

17) Select the figure that completes the series.

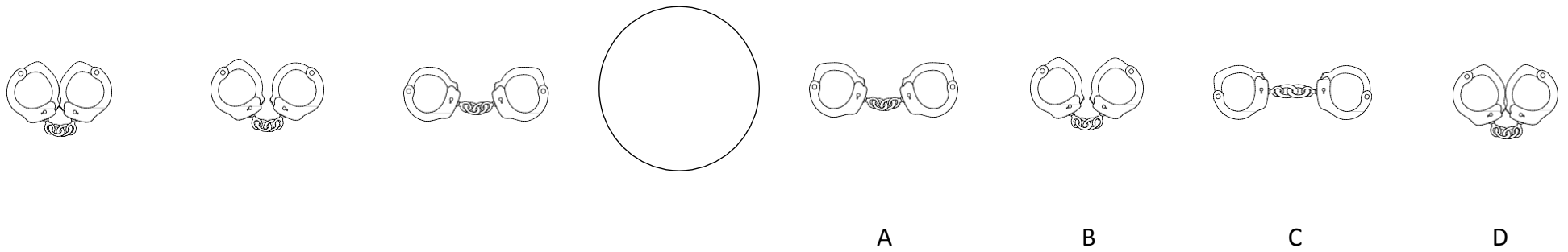

18) Select the figure that completes the series.

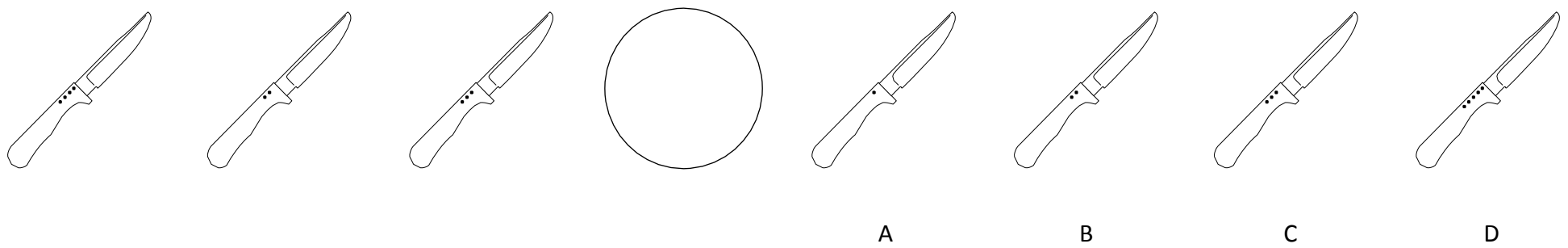

# Testing Tips and Practice Exercises

---

## Part 2 – Practice Exercises

### PRACTICE TEST ANSWER SHEET

- |     | A | B | C | D |
|-----|---|---|---|---|
| 1.  | { | { | { | { |
| 2.  | { | { | { | { |
| 3.  | { | { | { | { |
| 4.  | { | { | { | { |
| 5.  | { | { | { | { |
| 6.  | { | { | { | { |
| 7.  | { | { | { | { |
| 8.  | { | { | { | { |
| 9.  | { | { | { | { |
| 10. | { | { | { | { |
| 11. | { | { | { | { |
| 12. | { | { | { | { |
| 13. | { | { | { | { |
| 14. | { | { | { | { |
| 15. | { | { | { | { |
| 16. | { | { | { | { |
| 17. | { | { | { | { |
| 18. | { | { | { | { |

**Tear out this answer sheet, and compare your answers to the correct answers on the following page.**

---

## PRACTICE TEST CORRECT ANSWERS

Item #	Correct Answer	Explanation
1	(a)	It takes 2 minutes to drive one block, which is the fastest way.
2	(c)	You must drive 5 blocks at 2 minutes per block.
3	(b)	You must drive 4 blocks at 2 minutes per block and you must turn one corner, which takes an extra minute.
4	(c)	$3 + 6 = 9$
5	(b)	19 is larger than (in order) 9, 1, or 22/23
6	(a)	$4 - 3(14) = -(38)$ so 'm' has to equal 13 [ $13 + 1 = 14$ ]
7	(b)	All the other faces are smiling; all other characteristics are the same.
8	(b)	Three guns have short barrels; two of the short barrels are fat and one is not; both the fat and thin short barrels have sights; only one gun has a long barrel.
9	(c)	All the other cars have antennae up or down, and different numbers of horizontal stripes; only this car has a vertical stripe on the door.
10	(b)	6 firearms divided by 2 police officers.
11	(c)	Starting from the 1 <sup>st</sup> to the 31 <sup>st</sup> , there are 16 odd-numbered days (1 <sup>st</sup> , 3 <sup>rd</sup> , 5 <sup>th</sup> , 7 <sup>th</sup> , 9 <sup>th</sup> , 11 <sup>th</sup> , 13 <sup>th</sup> , 15 <sup>th</sup> , 17 <sup>th</sup> , 19 <sup>th</sup> , 21 <sup>st</sup> , 23 <sup>rd</sup> , 25 <sup>th</sup> , 27 <sup>th</sup> , 29 <sup>th</sup> , 31 <sup>st</sup> )
12	(c)	50% of the total value of the computer is worth \$1500 minus the \$300 for the TV, which is \$1200; the original value is double this.
13	(a)	All boys must be alive since they are people and all people are alive
14	(c)	All thieves must be criminals since they are prisoners and all prisoners are criminals
15	(a)	Some women must be police officers since some Chiefs of Police are women and all Chiefs of Police are police officers.
16	(d)	First curve goes up to the right, next goes down to the left, next goes up to the left, final has to go down to the right.
17	(c)	The handcuffs are increasingly spread out from the one another until the two cuffs are fully extended.
18	(a)	The first knife has 4 dots, the second has 2 dots, the third has 3 dots, and so the fourth has to have two fewer dots than the third.

---

# Testing Tips and Practice Exercises

---

## Part 2 – Practice Exercises

### Written Communication

This exercise involves reading a short scenario and then summarizing the events in a logical manner to make a conclusion as to what happened.

Read the scenario very carefully. The information has not been organized. Based on your observations and comments from witnesses, prepare a report to help the police understand what happened.

1. List, in point form, all the facts you think are important under the following headings: time, location and evidence at the scene.
2. In essay form, reconstruct what you think happened, drawing on the information you have listed. Clearly demonstrate how the facts you have chosen support your view of the incident. Be careful with your spelling and grammar.

Scenario:

A blue Jeep was on the other side of the street from the Mazda. It is June 13. Ms. Helen Elogar parked her car facing west at 10:20 a.m. When she returned to her car, Ms. Elogar found the paint on her driver's door had been scratched. The owner of a grey Chevette had parked his car at 10:30 a.m. A blue Jeep was parked, facing east. Most of the parking spaces were blocked by craft displays. There was a shopping cart overturned in the street, beside a grey Chevette. There was a large community sale being conducted in front of the stores. A red Mazda was parked in front of the Coarville Pharmacy. The police were notified of the damage at 10:52 a.m. A Chevette was parked in front of the Mazda. Traffic was detouring around a shopping cart which was blocking the westbound lane. The pharmacy is at 342

Elm Street. It was a very windy day. There were a lot of people on the sidewalk. All of Ms. Elogar's purchases were in her car. There were only three vehicles parked along the street. There was red paint evident on the front right corner of the shopping cart. The owner of the grey Chevette said he had

parked in front of the red Mazda, and that he had taken the last available parking spot. He stated that the shopping cart was not there when he pulled in.

Summarize the above information to describe what may have taken place. Draw any interpretations and conclusions you can about the incident.

---

# Testing Tips and Practice Exercises

---

## Part 2 – Practice Exercises

### Written Communications Answer Key

In order to complete the “report” regarding this occurrence, you will need to:

- gather the information;
- decide what information is important to the investigation of the occurrence;
- organize the information in broad categories, such as time, location, evidence at the scene; and,
- draw your conclusions as to what happened.

It may be helpful to go through the scenario and make a list on scrap paper of the facts that are important and then make your interpretations and conclusions based on this list. To make this practice scenario easier for you, very few non-relevant pieces of information have been included. Pay attention to each fact which has been presented in the scenario and try to link facts together to make it easy to make a judgment as to what happened. When you have come to a conclusion about what events happened and in what order they happened, check it against the facts presented, just to be sure you have not assumed anything.

Developing a point form outline before you write your final copy may save you time. Check the clock occasionally, to make sure you are not taking too long to complete this question. You will be given one hour to complete this test, so don't spend so long on the point form list that you run out of time, before you have completed the essay. Try to allow yourself time to check your work; correct any spelling or grammar mistakes you find.

The following is an example of the type of answer expected. Please remember that you may have a different writing style or that you may view the facts differently. The aim is to express your ideas clearly and to support your version of the events with the facts provided.

#### Important Facts:

##### Time

- June 13
- 10:52 a.m. call received
- 10:20 a.m. Mazda parked
- 10:30 a.m. Chevette parked

##### Location

- Parking space in front of 342 Elm St., Coarville.

# Testing Tips and Practice Exercises

---

## Part 2 – Practice Exercises

### Written Communications Answer Key (cont'd)

#### Evidence at the scene

- red Mazda parked behind grey Chevette
- driver's door scratched on Elogar's car
- shopping cart overturned in street
- a lot of people on sidewalk
- red paint evident on front right corner of shopping
- cart only 3 vehicles parked on street

#### Other

- windy day

#### Report:

The damage to Ms. Elogar's car, a red Mazda, occurred between 10:30 a.m. and 10:52 a.m. on June 13, in front of the Coarville Pharmacy at 342 Elm Street. Since the shopping cart was overturned beside the Chevette, and was blocking the lane, the Chevette would have been unable to park around it. The owner of the Chevette said he had parked in front of the Mazda at 10:30 a.m. Therefore, the incident must have occurred after 10:30 a.m. since the call was received by the police at 10:52 a.m.

The most likely explanation for the damage is that the shopping cart had been left on the street, and the wind then pushed it into Ms. Elogar's car. The impact of this then slowed the shopping cart, and perhaps set it off balance, so that it fell over into the street, beside the Chevette. As there were a lot of people on the sidewalk, it is very likely that someone would have seen the incident, and could verify this theory.

Once again, familiarize yourself with these types of questions in order to be well-prepared for your testing session.

**Good luck!**